



Cambridge Assessment International Education
Cambridge International General Certificate of Secondary Education

PHYSICS

0625/21

Paper 2 Multiple Choice (Extended)

October/November 2019

45 minutes

Additional Materials: Multiple Choice Answer Sheet
Soft clean eraser
Soft pencil (type B or HB recommended)



READ THESE INSTRUCTIONS FIRST

Write in soft pencil.

Do not use staples, paper clips, glue or correction fluid.

Write your name, centre number and candidate number on the Answer Sheet in the spaces provided unless this has been done for you.

DO NOT WRITE IN ANY BARCODES.

There are **forty** questions on this paper. Answer **all** questions. For each question there are four possible answers **A, B, C** and **D**.

Choose the **one** you consider correct and record your choice in **soft pencil** on the separate Answer Sheet.

Read the instructions on the Answer Sheet very carefully.

Each correct answer will score one mark. A mark will not be deducted for a wrong answer.

Any rough working should be done in this booklet.

Electronic calculators may be used.

Take the weight of 1.0 kg to be 10 N (acceleration of free fall = 10 m/s^2).

This syllabus is regulated for use in England, Wales and Northern Ireland as a Cambridge International Level 1/Level 2 Certificate.

This document consists of **15** printed pages and **1** blank page.

- 1 A student measures the diameter of a pencil.

Which measuring instrument will give the most precise reading?

- A a measuring tape
- B a metre rule
- C a micrometer screw gauge
- D a ruler

- 2 A light object is dropped from rest. It falls a large distance vertically through air.

How can the motion of the object be described?

- A constant acceleration
- B increasing acceleration
- C decreasing acceleration and then moving at terminal velocity
- D increasing acceleration and then moving at terminal velocity

- 3 A car travels at an average speed of 60 km/h for 15 minutes.

How far does the car travel in 15 minutes?

- A 4.0 km
- B 15 km
- C 240 km
- D 900 km

- 4 Which quantity is a force due to a gravitational field?

- A density
- B mass
- C weight
- D volume

- 5 The density of air is 1.2 kg/m^3 .

A room has dimensions $5.0 \text{ m} \times 4.0 \text{ m} \times 3.0 \text{ m}$.

What is the mass of the air in the room?

- A 0.02 kg
- B 0.10 kg
- C 50 kg
- D 72 kg

- 6 A car is travelling around a circular track at a constant speed, as shown.

In which direction is the resultant force on the car?

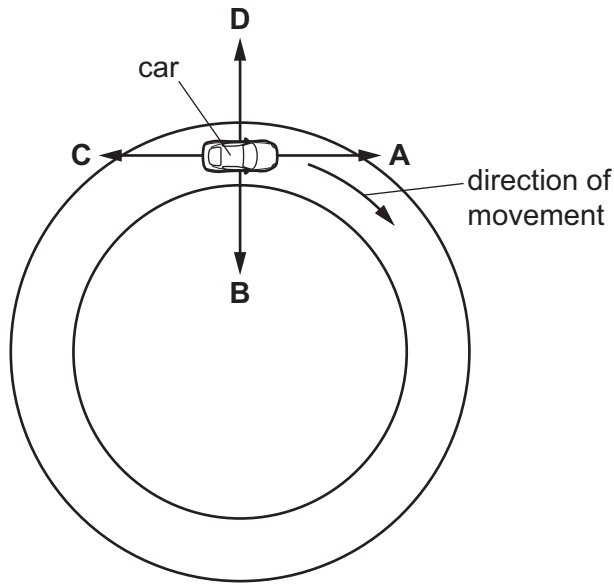

- 7 Two forces P and Q act on a metre rule as shown. The metre rule is pivoted at one end. The rule starts to rotate in a clockwise direction.

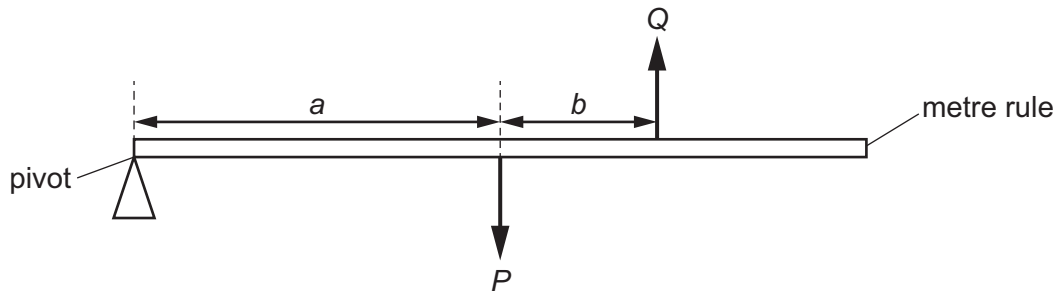

Which statement is correct?

- A P equals Q
 - B P is less than Q
 - C $(P \times a)$ is equal to $(Q \times b)$
 - D $(P \times a)$ is greater than $(Q \times (a + b))$
- 8 Which statement gives a complete description of any object that is in equilibrium?
- A There are no forces acting.
 - B There is no resultant force.
 - C There is no resultant force and no resultant turning effect.
 - D There is no resultant turning effect.

- 9 Two objects X and Y move directly towards each other. The objects have the same mass. Object X has a velocity of 5.0 m/s to the right. Object Y has a velocity of 3.0 m/s to the left.



Object X and object Y collide and stick together.

What is their velocity after colliding?

- A** 1.0 m/s to the left
B 1.0 m/s to the right
C 4.0 m/s to the left
D 4.0 m/s to the right
- 10 Brakes are used to slow down a moving car.
Into which form of energy is most of the kinetic energy converted as the car slows down?
A chemical
B elastic
C thermal
D sound
- 11 A man carries 20 tiles from the ground to the roof of a house. Each tile has a mass of 1.2 kg. The roof of the house is 15 m above the ground.
How much work does the man do against gravity on the tiles in carrying them to the roof?
A 36 J **B** 180 J **C** 360 J **D** 3600 J
- 12 A car is moving along a straight horizontal road. The car has 1.6 MJ of kinetic energy. The car accelerates for 20 s until the kinetic energy of the car increases to 2.5 MJ.
What is the minimum average power developed by the car engine for this acceleration?
A 45 W **B** 205 W **C** 45 kW **D** 205 kW

13 A drawing pin (thumb tack) has a sharp point at one end and a flat surface at the other end.

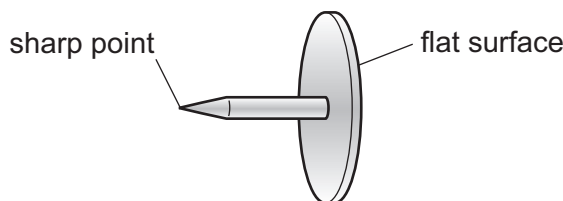

The pin is pushed into a wooden board.

How do the pressure and the force at the sharp point compare with the pressure and the force on the flat surface?

	force at the sharp point	pressure at the sharp point
A	greater than on the flat surface	greater than on the flat surface
B	greater than on the flat surface	less than on the flat surface
C	the same as on the flat surface	greater than on the flat surface
D	the same as on the flat surface	less than on the flat surface

14 An object is 20 cm below the surface of a liquid. The density of the liquid is 1200 kg/m^3 .

What is the pressure on the object due to the liquid?

- A** 600 Pa **B** 2400 Pa **C** 60 000 Pa **D** 240 000 Pa

15 Which statement about the evaporation of a liquid is correct?

- A** The least energetic molecules escape from the surface and the temperature of the liquid decreases.
- B** The least energetic molecules escape from the surface and the temperature of the liquid increases.
- C** The most energetic molecules escape from the surface and the temperature of the liquid decreases.
- D** The most energetic molecules escape from the surface and the temperature of the liquid increases.

16 A bubble of gas is formed deep under water. The bubble has a volume of 40 cm^3 and the pressure inside the bubble is P .

The bubble rises up through the water. The volume of the bubble increases to 56 cm^3 and the pressure becomes 100 kPa. The temperature of the gas does not change.

What is the initial pressure P ?

- A** 71 Pa **B** 71 kPa **C** 140 Pa **D** 140 kPa

17 Which change in the design of a liquid-in-glass thermometer makes it more sensitive?

- A a larger liquid reservoir
- B a longer tube
- C a smaller liquid reservoir
- D a wider tube

18 A liquid turns into a gas. This occurs only at one particular temperature, and the change happens throughout the liquid.

What is this process called?

- A boiling
- B condensation
- C evaporation
- D fusion

19 One end of a rod of copper is placed in hot water. Thermal energy travels along the rod to make the other end warmer.

What is the behaviour of the copper at an atomic level that accounts for most of the transfer of thermal energy from one end to the other?

- A Atoms at the hot end gain kinetic energy and move towards the other end.
- B Atoms at the hot end expand, colliding with other atoms and transferring energy.
- C Free electrons at the hot end gain energy and move towards the other end, colliding with atoms along the rod.
- D Free electrons at the hot end gain energy from the hot water and move directly to the other end.

20 A surface is made so that it is a good source of infrared radiation.

Which surface is **not** suitable?

- A a surface that is painted matt black
- B a surface that is painted white
- C a surface that is heated to a high temperature
- D a surface that has a large surface area

21 A large hill blocks the direct path between a transmitter of radio waves and a receiver, as shown.

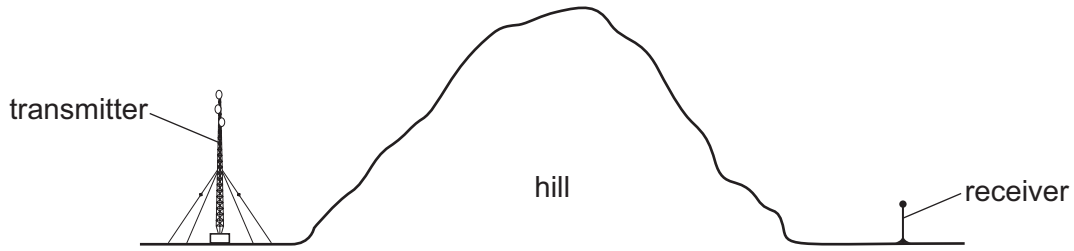

The receiver picks up the signal from the transmitter even though the radio waves do not travel through the hill.

Which row is correct?

	A possible way for this to happen is	A stronger signal is received using
A	diffraction round the hill.	longer wavelengths.
B	diffraction round the hill.	shorter wavelengths.
C	refraction round the hill.	longer wavelengths.
D	refraction round the hill.	shorter wavelengths.

22 The diagram shows the image of a clock in a plane mirror.



Which is the actual time?

- A** 04:15 **B** 04:45 **C** 07:15 **D** 07:45

23 A converging lens produces an image of an object O. The focal length of the lens is f .

Which position of the object produces a virtual image?

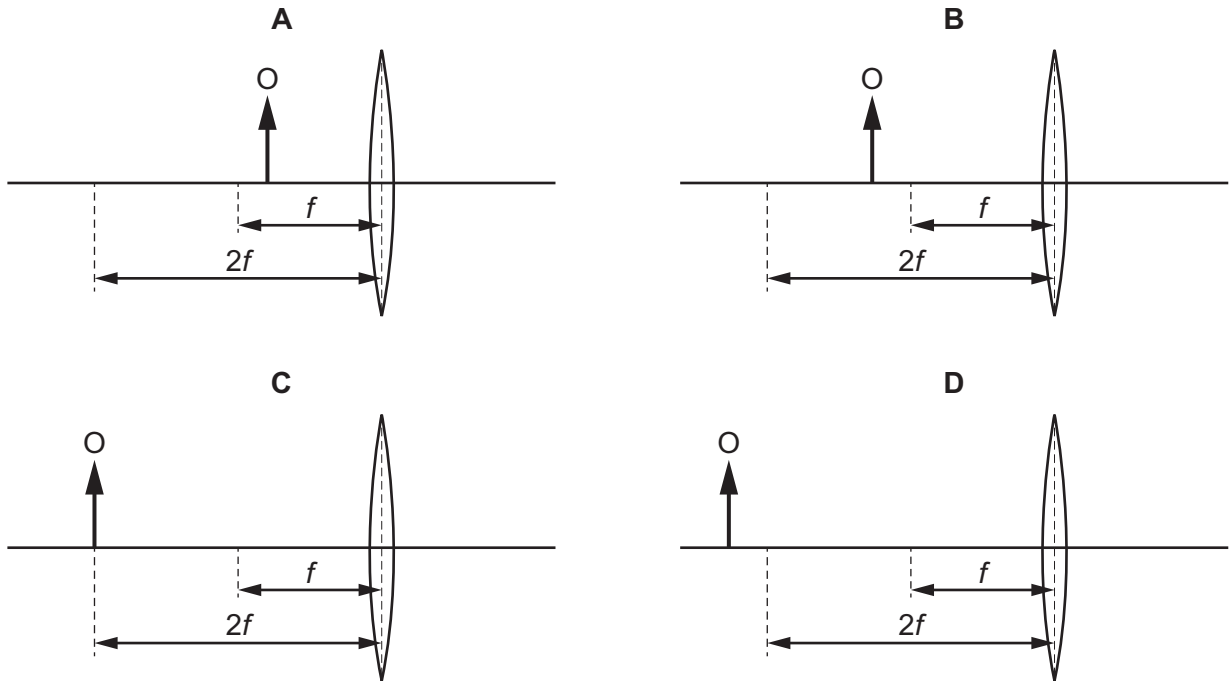

24 The diagram shows the electromagnetic spectrum.

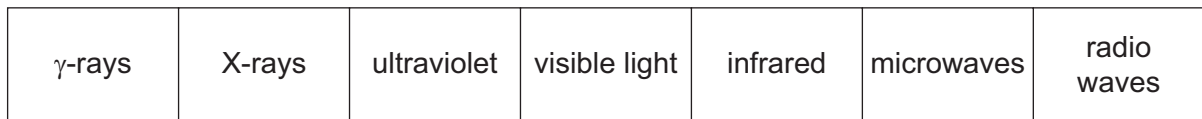

increasing \rightarrow

A word is missing from the label below the spectrum.

Which word is missing?

- A amplitude
- B frequency
- C speed
- D wavelength

25 Which row gives a possible set of values for the speed of sound in ice, in water and in steam?

	<u>speed of sound in ice</u> m/s	<u>speed of sound in water</u> m/s	<u>speed of sound in steam</u> m/s
A	500	1500	4000
B	1500	4000	500
C	4000	500	1500
D	4000	1500	500

26 A steel bar is placed in an East-West direction for it to be demagnetised. No other magnet is nearby.

Which method is **not** suitable?

- A** Hammering the bar.
- B** Heating the bar to a very high temperature.
- C** Slowly taking the bar out of a coil that carries an alternating current.
- D** Slowly taking the bar out of a coil that carries a direct current.

27 A plastic rod is rubbed with a dry cloth. The rod becomes positively charged.

Why has the rod become positively charged?

- A** It has gained electrons.
- B** It has gained neutrons.
- C** It has lost electrons.
- D** It has lost neutrons.

28 A circuit contains a cell of electromotive force (e.m.f.) of 2.0V. The current in the circuit is 2.0A.

How much energy is converted by the cell in 2.0 minutes?

- A** 2.0J **B** 4.0J **C** 8.0J **D** 480J

29 The circuit diagram shows a cell connected in series to a resistor and a component X.

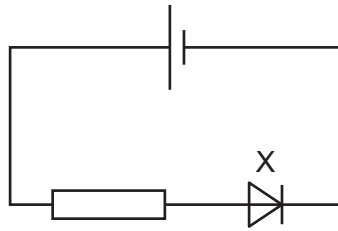

What is component X?

- A bell
- B diode
- C heater
- D thermistor

30 Identical resistors are connected together to form arrangements X, Y and Z.

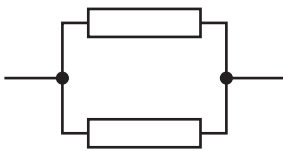

X



Y

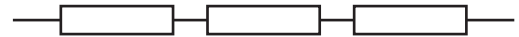

Z

What is the correct order of the resistances of the arrangements from the largest to the smallest?

- A $X \rightarrow Y \rightarrow Z$
- B $Y \rightarrow X \rightarrow Z$
- C $Z \rightarrow X \rightarrow Y$
- D $Z \rightarrow Y \rightarrow X$

- 31 A circuit contains a cell of electromotive force (e.m.f.) 2.0 V, three resistors, three ammeters and two voltmeters. One ammeter is labelled P and one voltmeter is labelled Q.

The readings on the other two ammeters and on the other voltmeter are shown.

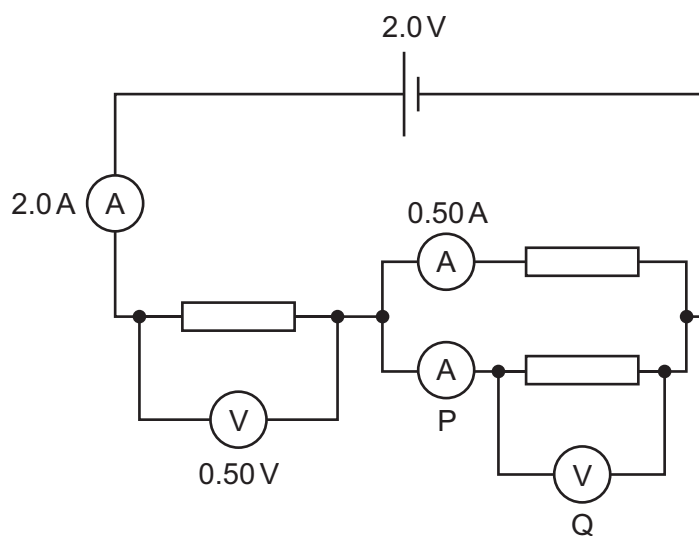

What is the reading on ammeter P and what is the reading on voltmeter Q?

	reading on P/A	reading on Q/V
A	1.5	1.5
B	1.5	2.5
C	2.5	1.5
D	2.5	2.5

32 There are two inputs and one output for the combination of logic gates shown.

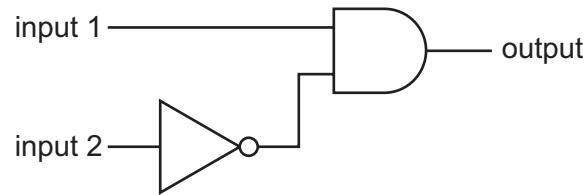

Which truth table represents the operation of this combination of logic gates?

A

input 1	input 2	output
0	0	0
0	1	0
1	0	1
1	1	1

B

input 1	input 2	output
0	0	0
0	1	0
1	0	1
1	1	0

C

input 1	input 2	output
0	0	1
0	1	1
1	0	0
1	1	0

D

input 1	input 2	output
0	0	1
0	1	0
1	0	1
1	1	1

33 Where must a fuse be connected in a mains electric circuit?

- A** the earth wire only
- B** the live wire only
- C** the neutral wire only
- D** the live wire and the earth wire

34 A student investigates the output voltage induced across a coil of wire by a bar magnet.

When will the induced voltage have the greatest value?

- A** The student slowly moves the bar magnet into the coil of wire.
- B** The student leaves the bar magnet stationary in the coil of wire.
- C** The student quickly removes the bar magnet from the coil of wire.
- D** The student places the bar magnet at rest outside the coil of wire.

35 There is a current in a wire. The direction of the current is out of the page.

Which diagram shows the magnetic field pattern produced?

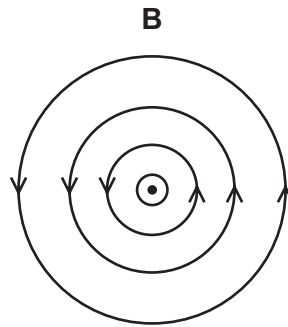
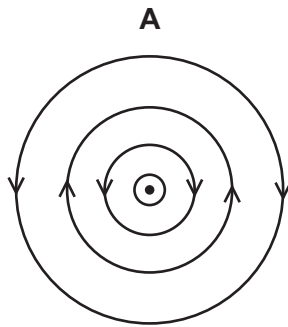

key

⊙ wire carrying a current out of the page

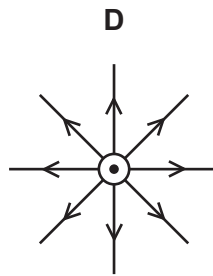
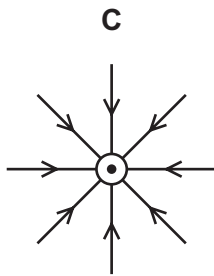

36 Diagram 1 shows a coil of wire P between the poles of a magnet. The ends of coil P are connected to a battery by slip rings.

Diagram 2 shows a coil of wire Q between the poles of a different magnet. The ends of coil Q are connected to a battery by a split-ring commutator.

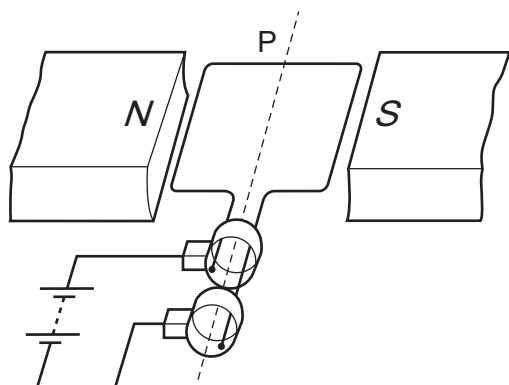

diagram 1

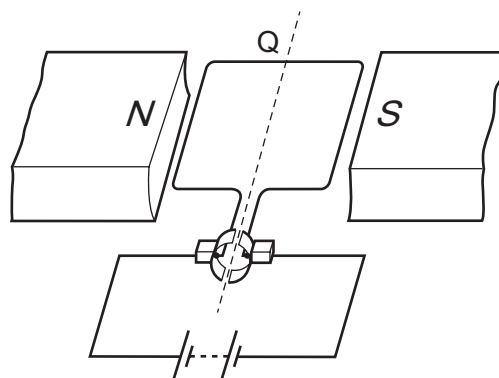
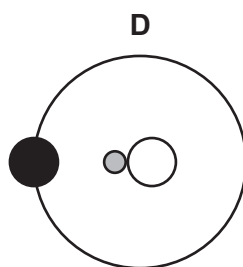
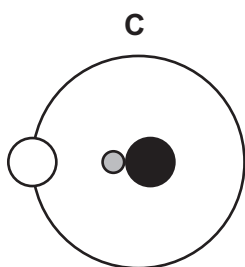
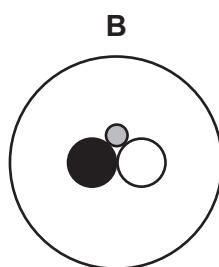
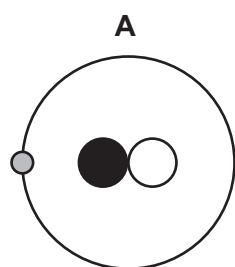

diagram 2

What happens to coils P and Q?

	coil P	coil Q
A	continuously turns anticlockwise	makes one quarter turn anticlockwise then stops
B	continuously turns clockwise	makes one quarter turn clockwise then stops
C	makes one quarter turn anticlockwise then stops	continuously turns anticlockwise
D	makes one quarter turn clockwise then stops	continuously turns clockwise

37 Which diagram shows a possible structure of a neutral atom?



key

● proton

○ neutron

● electron

- 38 The scattering of particles by a thin gold foil provided scientists with evidence for the nuclear atom.

Which particles were scattered by the gold nuclei in the thin foil?

- A α -particles
 - B β -particles
 - C neutrons
 - D protons
- 39 The diagram shows β -particles being directed between the poles of a magnet.

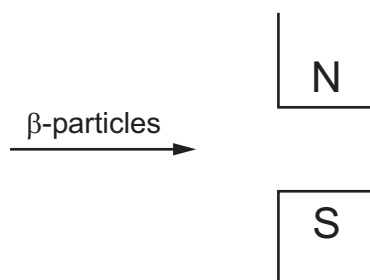

In which direction will the particles be deflected?

- A into the page
 - B out of the page
 - C towards the bottom of the page
 - D towards the top of the page
- 40 Why are some radioactive sources stored in boxes made from lead?
- A Lead absorbs emissions from the radioactive sources.
 - B Lead decreases the half-life of radioactive sources.
 - C Lead increases the half-life of radioactive sources.
 - D Lead repels emissions from the radioactive sources.

BLANK PAGE

Permission to reproduce items where third-party owned material protected by copyright is included has been sought and cleared where possible. Every reasonable effort has been made by the publisher (UCLES) to trace copyright holders, but if any items requiring clearance have unwittingly been included, the publisher will be pleased to make amends at the earliest possible opportunity.

To avoid the issue of disclosure of answer-related information to candidates, all copyright acknowledgements are reproduced online in the Cambridge Assessment International Education Copyright Acknowledgements Booklet. This is produced for each series of examinations and is freely available to download at www.cambridgeinternational.org after the live examination series.

Cambridge Assessment International Education is part of the Cambridge Assessment Group. Cambridge Assessment is the brand name of the University of Cambridge Local Examinations Syndicate (UCLES), which itself is a department of the University of Cambridge.