



Cambridge O Level

PHYSICS

5054/11

Paper 1 Multiple Choice

May/June 2020

1 hour

You must answer on the multiple choice answer sheet.

You will need: Multiple choice answer sheet
Soft clean eraser
Soft pencil (type B or HB is recommended)

INSTRUCTIONS

- There are **forty** questions on this paper. Answer **all** questions.
- For each question there are four possible answers **A, B, C** and **D**. Choose the **one** you consider correct and record your choice in soft pencil on the multiple choice answer sheet.
- Follow the instructions on the multiple choice answer sheet.
- Write in soft pencil.
- Write your name, centre number and candidate number on the multiple choice answer sheet in the spaces provided unless this has been done for you.
- Do **not** use correction fluid.
- Do **not** write on any bar codes.
- You may use a calculator.

INFORMATION

- The total mark for this paper is 40.
- Each correct answer will score one mark. A mark will not be deducted for a wrong answer.
- Any rough working should be done on this question paper.

This document has **16** pages. Blank pages are indicated.

- 1 The diagram shows the resultant R of a 3.0 N force and a 4.0 N force that act at a point P .

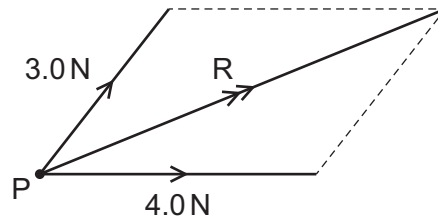

The angle between the 3.0 N force and the 4.0 N force can be any value from 0° to 90° .

Which value of R is **not** possible?

- A** 4.0 N **B** 5.0 N **C** 6.0 N **D** 7.0 N
- 2 What is measured using a micrometer?
- A** area
B current
C length
D mass
- 3 The graph shows a short journey. It is a speed–time graph.

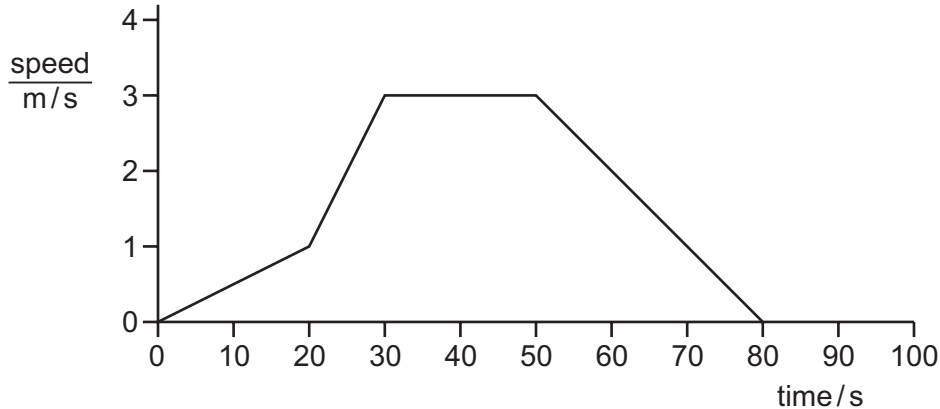

What is the greatest speed reached?

- A** 1 m/s **B** 2 m/s **C** 3 m/s **D** 4 m/s
- 4 A car of weight $11\,000\text{ N}$ moves with constant velocity along a horizontal road. A driving force of $5\,000\text{ N}$ acts on the car.
- What is the force opposing the motion of the car?
- A** $5\,000\text{ N}$ **B** $6\,000\text{ N}$ **C** $11\,000\text{ N}$ **D** $16\,000\text{ N}$

5 A man with an open parachute falls to Earth at constant speed. The following forces act:

- P the upward force of the parachute on the man
- Q the upward force of the man on the Earth
- R the downward force of the Earth on the parachute
- S the downward force of the man on the parachute

Which two forces are a Newton's third law pair?

- A P and Q B P and R C P and S D Q and R

6 A box is pulled up a rough slope, as shown.

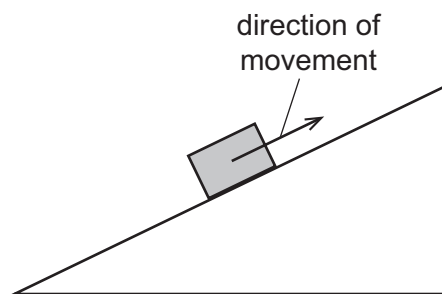

In which direction does friction act on the box?

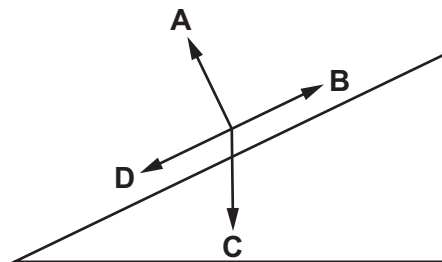

7 The diagram shows a motorcyclist leaning over in order to turn the corner to the left.

Which force causes him to turn?

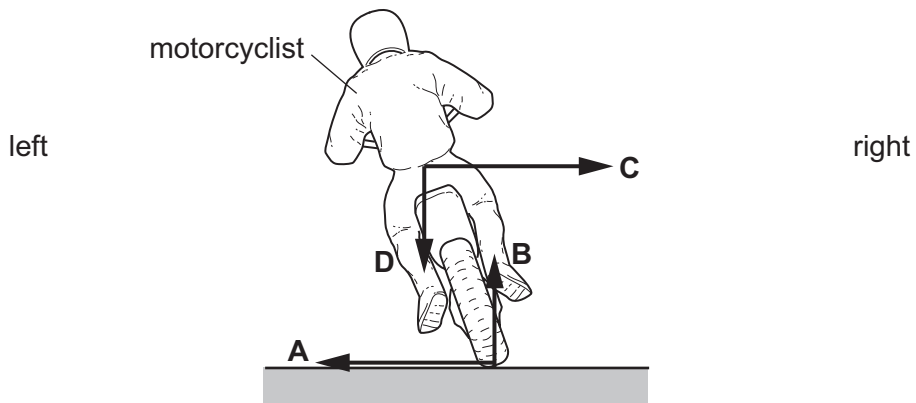

8 Which type of force causes the Earth to orbit the Sun?

- A elastic
- B electrostatic
- C gravitational
- D magnetic

9 Four objects of different masses are on different planets.

The weight of each object on its planet is determined.

Which object is on the planet with the smallest gravitational field strength?

	mass / kg	weight / N
A	5	125
B	15	150
C	20	220
D	25	225

10 Which physical quantity does **not** change when a piece of copper is heated?

- A density
- B mass
- C temperature
- D volume

11 A single metal bolt has a mass of 34 g.

Three of the bolts are immersed in a measuring cylinder that contains 30 cm^3 of water.

The reading on the measuring cylinder rises to 42 cm^3 .

What is the density of the metal?

- A 0.81 g/cm^3
- B 2.8 g/cm^3
- C 7.5 g/cm^3
- D 8.5 g/cm^3

- 12 A rocket of mass M when empty carries a mass M of fuel. The rocket and fuel travel at speed v . The engine of the rocket is fired and all of the fuel is expelled. The speed of the rocket increases to $2v$.

What happens to the kinetic energy of the rocket?

- A It doubles.
 B It halves.
 C It increases by a factor of four.
 D It stays the same.
- 13 A car of mass 1000 kg is driven 200 m up an incline so that it rises 50 m vertically.

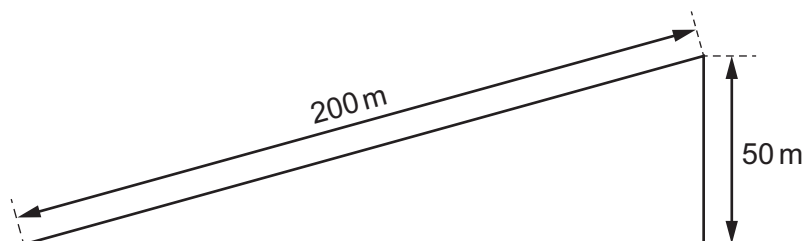

The acceleration of free fall g is 10 m/s^2 .

What is the gain in gravitational potential energy?

- A 5000 J B 200 000 J C 500 000 J D 2 000 000 J
- 14 A fish is swimming 15 m below the surface of a lake, as shown.

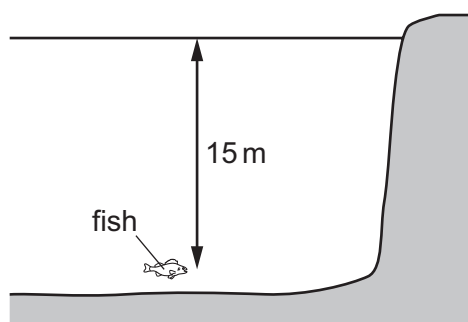

The density of the water is 1000 kg/m^3 .

Atmospheric pressure is 100 000 Pa.

The acceleration of free fall g is 10 m/s^2 .

What is the total pressure on the fish?

- A 50 000 Pa B 120 000 Pa C 150 000 Pa D 250 000 Pa

- 15 The diagram shows a mercury manometer. The tube is open to the atmosphere on the right-hand side.

The left-hand side is connected to a container containing a gas at pressure P .

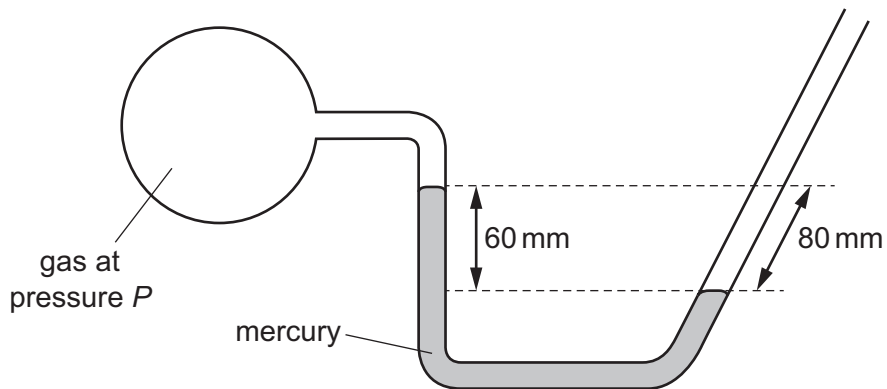

Atmospheric pressure on its own supports a column of mercury of height 756 mm.

Which height of column does pressure P on its own support?

- A 676 mm of mercury
 B 696 mm of mercury
 C 816 mm of mercury
 D 836 mm of mercury
- 16 In a weightlifting contest, an athlete lifts a metal bar of mass 20 kg fitted with a mass of 80 kg on each end.

The lift from ground to a height of 2.5 m takes 0.50 s.

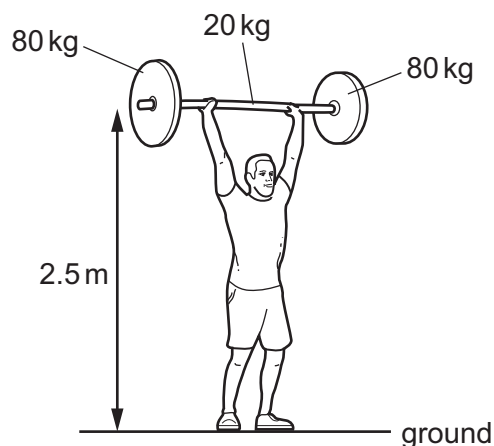

The gravitational field strength g is 10 N/kg.

What average power does the weightlifter exert in providing the gravitational potential energy during this lift?

- A 0.90 kW B 5.0 kW C 8.0 kW D 9.0 kW

17 A boy is standing by the side of a lake.

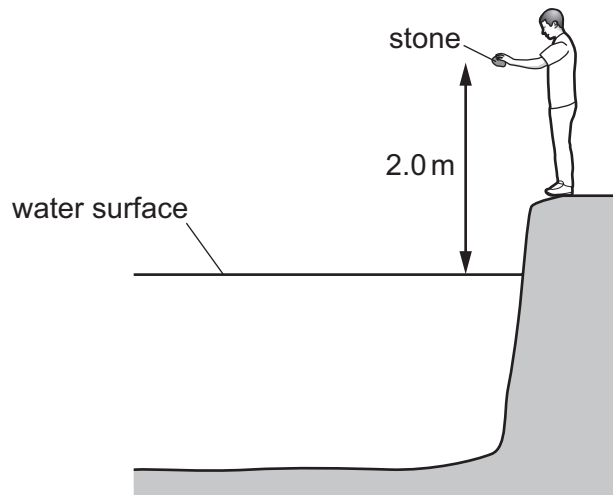

The boy drops a heavy stone from a height of 2.0 m above the water surface.

The acceleration due to gravity is 10 m/s^2 .

What is the speed of the stone when it hits the surface of the water?

- A** 4.5 m/s **B** 6.3 m/s **C** 20 m/s **D** 40 m/s

18 In which situation is energy being released by the fusion of hydrogen nuclei to form helium?

- A** in the decay of ^{14}C used to date an object
B in a radioactive isotope emitting alpha-particles
C in the centre of the Earth
D in the centre of the Sun

19 The diagram shows a block being pulled up a slope by a force F .

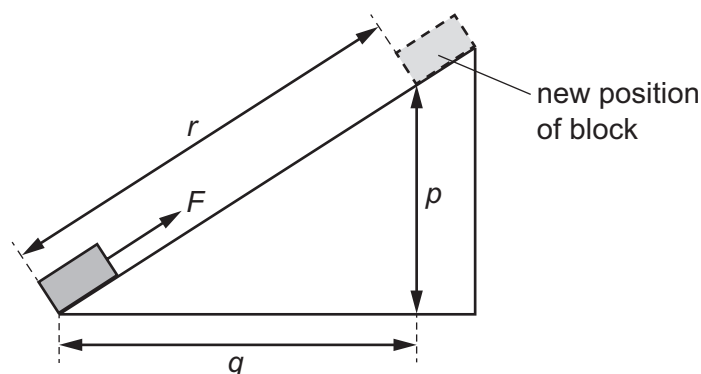

The block reaches the new position at the top of the slope.

What is the work done by force F in moving the block to its new position?

- A** $F \times r$ **B** $F \times p$ **C** $F(q + p)$ **D** $F(r + p)$

- 20 Which statement about a mercury-in-glass clinical thermometer is correct?
- A It covers a much larger range than an ordinary laboratory thermometer.
 - B It is more sensitive than an ordinary laboratory thermometer.
 - C Its scale is not linear.
 - D Its sensitivity is affected by the constriction in the capillary tube.

- 21 Which description of a dull black surface is correct?
- A good emitter, good absorber and good reflector of radiation
 - B good emitter, poor absorber and poor reflector of radiation
 - C good emitter, good absorber and poor reflector of radiation
 - D poor emitter, poor absorber and poor reflector of radiation

- 22 The temperature of a body increases by 1°C .

Which other quantity also increases?

- A heat capacity
 - B internal energy
 - C specific heat capacity
 - D specific latent heat
- 23 The thermal energy produced by an electric heater in three minutes is used to melt wax. The solid wax is initially at its melting point of 60°C .
- The specific latent heat of the wax is 220 J/g . The heater supplies 7700 J of thermal energy to the wax. Some of the wax melts.
- How much wax melts?
- A 0.58 g
 - B 1.7 g
 - C 12 g
 - D 35 g

- 24 Which row explains why a liquid has a fixed volume but does **not** have a fixed shape?

	force between molecules in the liquid	movement of molecules in the liquid
A	large	free to move within the liquid
B	large	vibrate at fixed positions
C	small	free to move within the liquid
D	small	vibrate at fixed positions

25 A fixed mass of gas is enclosed in a cylinder by a piston which is free to move.

Which combination of changes to the pressure and to the temperature **must** increase the density of the gas?

	pressure	temperature
A	decrease	decrease
B	decrease	increase
C	increase	decrease
D	increase	increase

26 Light enters a glass block at an angle of incidence i and it produces an angle of refraction r in the glass.

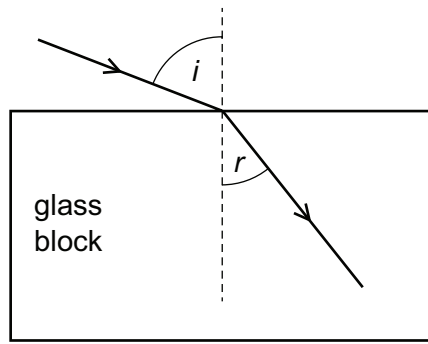

Several different values of i and r are measured, and a graph is drawn of $\sin i$ against $\sin r$.

Which graph is correct?

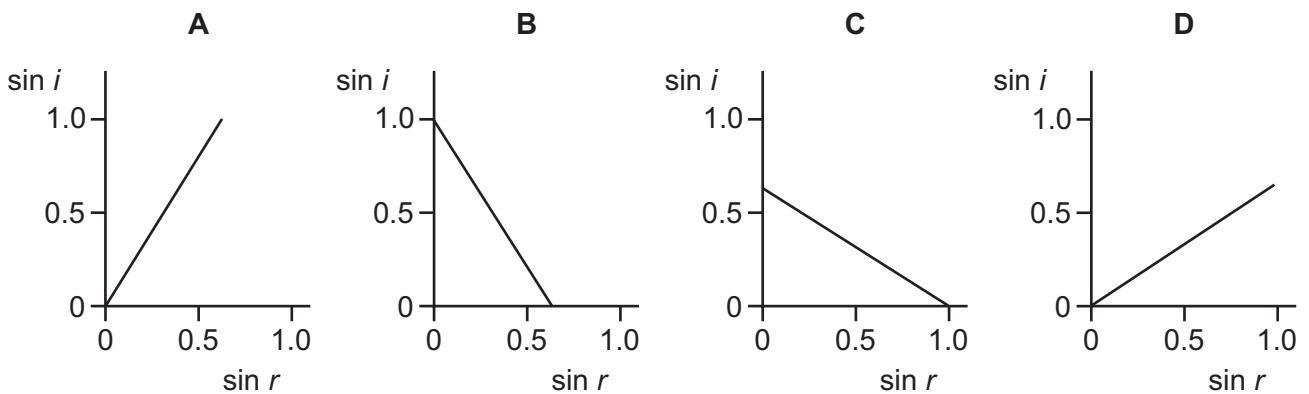

27 A swimming pool is lit by an underwater light.

A ray of light is incident on the water surface.

What is the correct path for the ray of light?

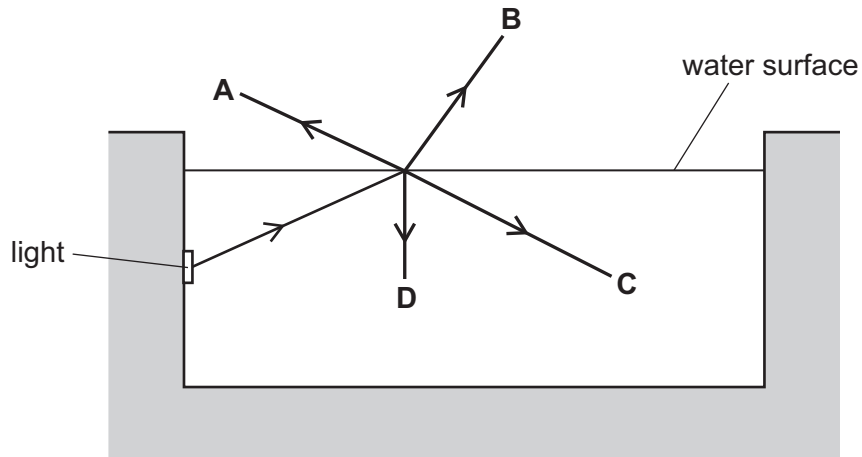

28 Which diagram shows the action of a converging lens on a parallel beam of light?

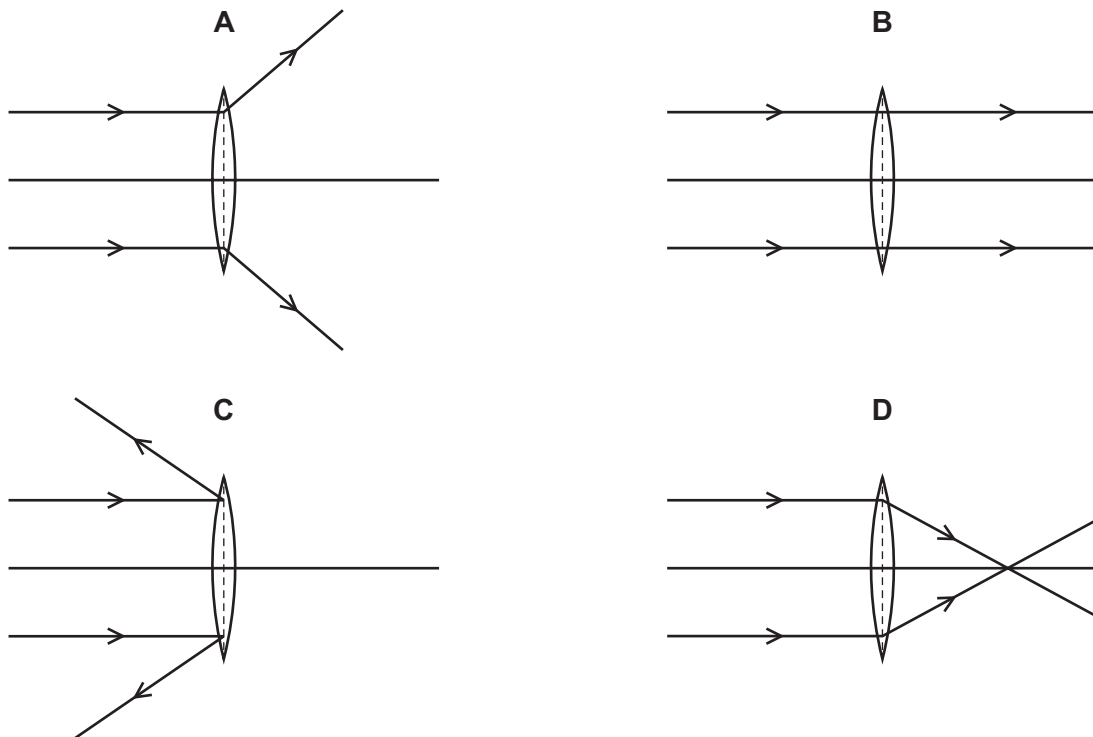

29 What is a feature of red light compared with that of violet light?

- A A prism deviates red light more.
- B Red light has a lower frequency.
- C Red light has a shorter wavelength.
- D The speed of red light in a vacuum is smaller.

30 What is the ratio of the longest sound wavelength audible to a healthy human ear to the shortest?

- A 20:1 B 1000:1 C 10 000:1 D 20 000:1

31 Ultrasound is used to clean jewellery in a liquid.

What is another use of ultrasound?

- A optical fibre communication
 B pre-natal scanning
 C sunbeds
 D telephone communications

32 Bar magnets and various non-magnetic and demagnetised metal bars are placed in the different arrangements shown.

In which arrangement do the bars repel?

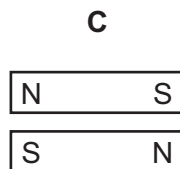
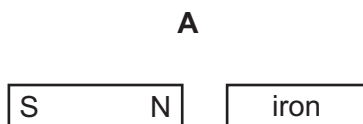

- 33 There is varying current in the coil of the loudspeaker shown. The loudspeaker is producing a sound. The magnet is clamped.

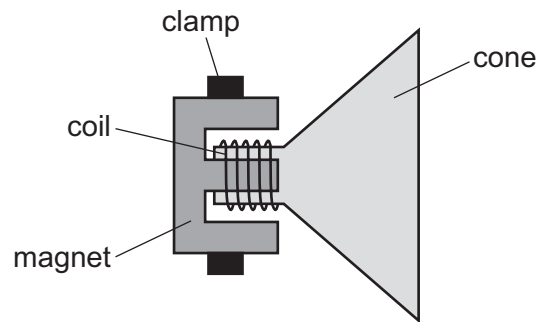

What is vibrating to produce the sound?

- A coil only
 - B cone only
 - C magnet only
 - D coil and cone
- 34 Two insulated and uncharged metal spheres X and Y are touching.
- A positively charged rod is held near X and then the spheres are moved apart.
- X now has a negative charge.

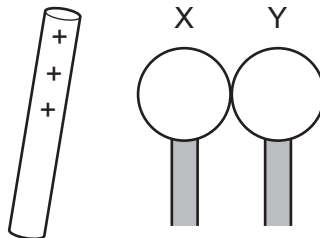

What is the charge on Y?

- A negative and smaller than that on X
- B negative and the same size as that on X
- C positive and smaller than that on X
- D positive and the same size as that on X

- 39 $^{14}_6\text{C}$ is a natural radioactive isotope of carbon and is present in all living things. It has a half-life of 5700 years.

How old is a bone that is found to have only $\frac{1}{4}$ of the natural proportion of $^{14}_6\text{C}$?

- A 5700 years
 - B 11 400 years
 - C 17 100 years
 - D 22 800 years
- 40 A kettle is connected to the 240 V mains supply using a plug containing a 13 A fuse.

The kettle contains water.

When it is switched on, the fuse blows. This happens again after a new fuse is fitted.

Someone replaces the fuse with a nail, and the kettle works.

What else might happen as a result of replacing the fuse with a nail?

- A A very large current overloads the wiring, causing a fire.
- B The kettle boils the water less quickly.
- C The kettle uses more energy to boil the water.
- D The water boils at a higher temperature.

BLANK PAGE

Permission to reproduce items where third-party owned material protected by copyright is included has been sought and cleared where possible. Every reasonable effort has been made by the publisher (UCLES) to trace copyright holders, but if any items requiring clearance have unwittingly been included, the publisher will be pleased to make amends at the earliest possible opportunity.

To avoid the issue of disclosure of answer-related information to candidates, all copyright acknowledgements are reproduced online in the Cambridge Assessment International Education Copyright Acknowledgements Booklet. This is produced for each series of examinations and is freely available to download at www.cambridgeinternational.org after the live examination series.

Cambridge Assessment International Education is part of the Cambridge Assessment Group. Cambridge Assessment is the brand name of the University of Cambridge Local Examinations Syndicate (UCLES), which itself is a department of the University of Cambridge.